

# User manual

---

28-10-2018

Version 2.0

*Company Information*

*Copyright and third-party information as required*

## Document Revisions

Date	Version Number	Document Changes
11/03/2017	1.0	First edition
27/10/2018	2.0	New version – remote control via MQTT server and smartphone app

## Table of Contents

1 Safety & Precaution.....	5
1 SmartPID SPC1000 overview.....	6
1.1 Scope and Purpose.....	6
1.2 SmartPID overview.....	6
2 SmartPID smart thermostat application.....	7
1.1 Single PID control - heating.....	8
1.2 Single PID control - heating and cooling (thermostatic).....	9
1.3 Dual ON/OFF control – cooling.....	9
3 Smart thermostat application SW.....	10
3.1 Basic control principle.....	10
3.2 Smart Thermostat application principle.....	12
4 Menu navigation.....	14
4.1 Main Menu.....	14
4.2 Status Mode.....	15
4.3 Configuration.....	15
4.3.1 HW setup.....	16
4.3.2 Unit Parameter.....	18
4.3.3 Process parameter.....	19
4.3.4 PID auto tuning.....	22
4.4 Ramp/Soak.....	23
4.5 Connectivity/MQTT.....	25
4.6 Run mode.....	27
5 Process Execution.....	28
6 Smartphone APP.....	30
6.1 Login and device list.....	30
6.2 Main dashboard.....	31
6.3 Commands.....	32
6.4 Data Export.....	33
6.5 Setup.....	33
7 Appendix.....	34
7.1 Zeigler-Nichols PID tune.....	34

## 1 Safety & Precaution

Ensure that the product is always used within the specifications

Do not use product close to flammable and explosive gas otherwise injury from explosion may occur

Never disassemble, modify, or touch any of the internal part to avoid electric shock or malfunctions

Do not use the relay over their life cycle and do not exceed the rated load of the outputs

Do not touch the terminals at least while power is being supplied. Doing so may occasionally result in injury due to electric shock.

⚠ Do not allow pieces of metal, wire clippings, or fine metallic shaving or filings from installation to enter the product.

Do not allow water or any liquid enter the product. Enclosure is not water proof

The board is sold as a DIY standalone component and people buying should take care of connecting and integrating with their own system. The manula connection diagram and short explanations but minimum expertise in electric circuit is needed.

The board is powered by **High Voltage 220/110V** so you must be very careful and all connections are at your own risk. If you are not familiar with electricity and power please ask a technician to help you. I'm not responsible for any damage or risk you can create



# 1 SmartPID SPC1000 overview

## 1.1 Scope and Purpose

The purpose of this document is to describe in detail the user application software called **smart thermostat app**. The document provide the support to configure the application SW and run all different use cases

For the HW installation and basic configuration (including wifi) please refer to proper manuals.

## 1.2 SmartPID overview

The smartPID controller has been designed to replace low cost simple thermoregulator with a smart controller that can be programmed and adapted to any process.

Using the Same DIN enclosure SmartPID microcontroller could replace almost plug an play the standard thermostat in any possible application

- process enhancement and full automation (heating, cooling,thermostatic)
- flexible programming (single set point or profile with ramp/soak definition)
- Higher accuracy (PID control)
- Wide variety of HW (5 different outputs)
- Remote control via dedicated smartphone app or web

In term of technical characteristic SmartPID support



- Dual Independent channels
- PID control and ON/OFF control with hysteresis
- 2x Relays output
- 1 SSR Output
- 2 x 12V 2A power output
- 2 Digital temperature probe input OR NTC input (configurable)
- OLED graphic display
- On Board EEPROM for data logging and parameter configuration/recipe store
- Process data logging
- SW update and loading via USB
- WiFi connection to remote server
- Buzzer events indication
- 4 push button interaction
- 220V power supply

The SmartPID controller is complemented by the **dedicated smartphone app** that allow the user to remote control the brewing process

For details on how to pair the smartPID with the app and configure wifi and thingspeak service please refer to installation and integration manual

## 2 SmartPID smart thermostat application

Via HW configuration SmartPID can be adapted to manage in a very flexible way different set up and solutions. The HW configuration allows to assign different processes/logical channels to different physical HW resources. This provide great flexibility to manage different heating source (gas or electric) and different cooling method (traditional fridge, TEC cooling systems )

3 main control mode are supported

- a) **heating**: controller manage an heating systems to reach set point temperature and keep it stable
- b) **cooling**: controller manage a cooling system to to reach set point temperature and keep it stable
- c) **thermostatic**: controller activate either a cooling and heating systems to keep temparture at certain set point value regardless external temperature value

Below some example to illustrate the flexibility and multiple configurations possible

### 1.1 Single PID control - heating

SmartPID reads temperature from 1 probe and drive the heating element in order to reach the setup temperature

In the example DC1 out is connected to a solid state relay to drive power heating element and the heating power is controlled by PID-PWM algorithm 0-100%

for load up to 10A you can use one of the internal mechanical relay

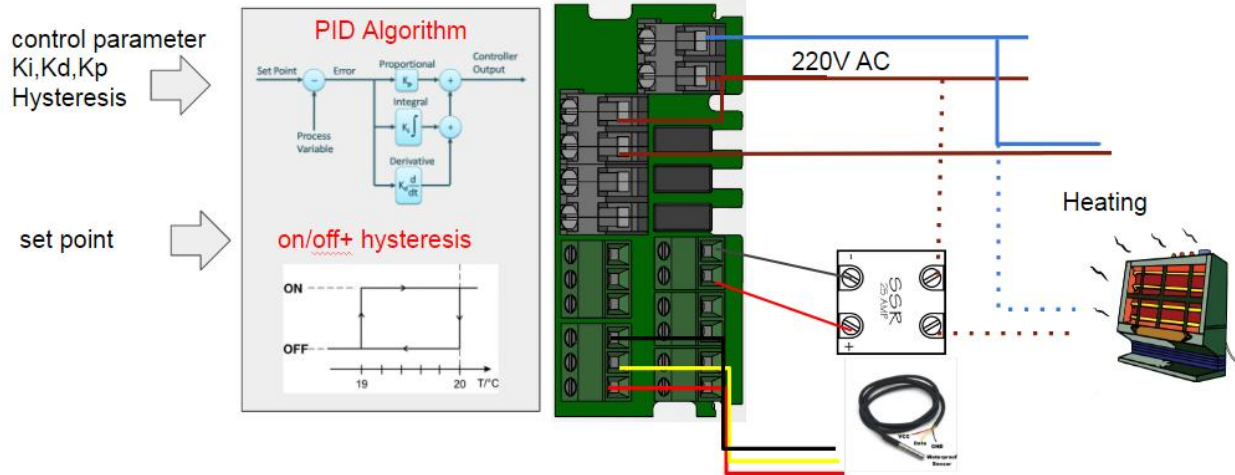



### 1.2 Single PID control - heating and cooling (thermostatic)

SmartPID reads temperature from 1 probe and drive the heating element OR cooling element in order to get the setup temp with a thermostatic control

In the example 220V AC relay are used to drive heating element and cooling element (compressor)

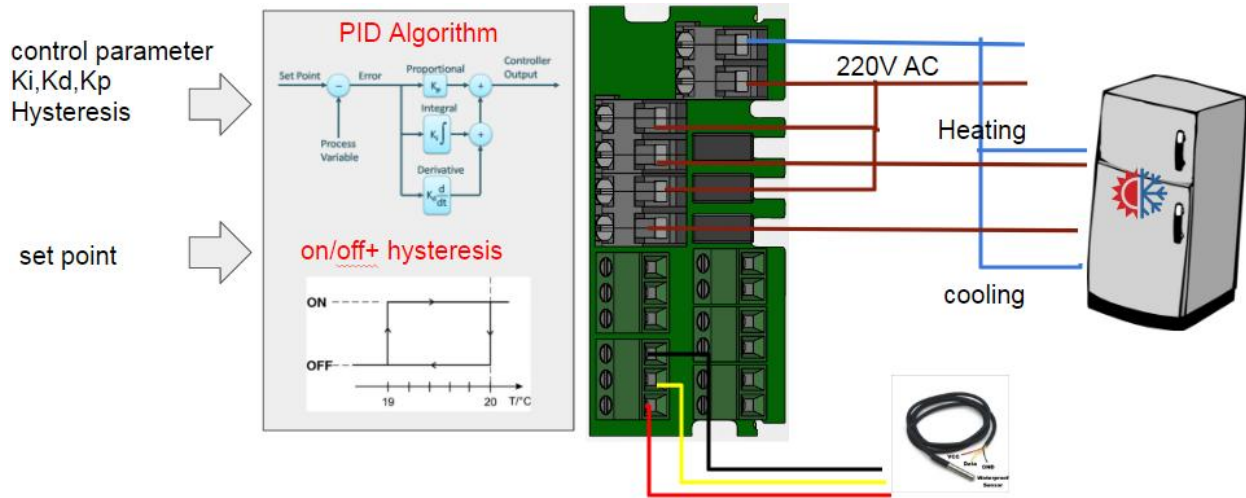

### 1.3 Dual ON/OFF control – cooling

SmartPID reads temperature from 2 probes and drive 2 fridges independently in order to get the setup temperature

in the example 2x SSR are used to drive fridge compressors

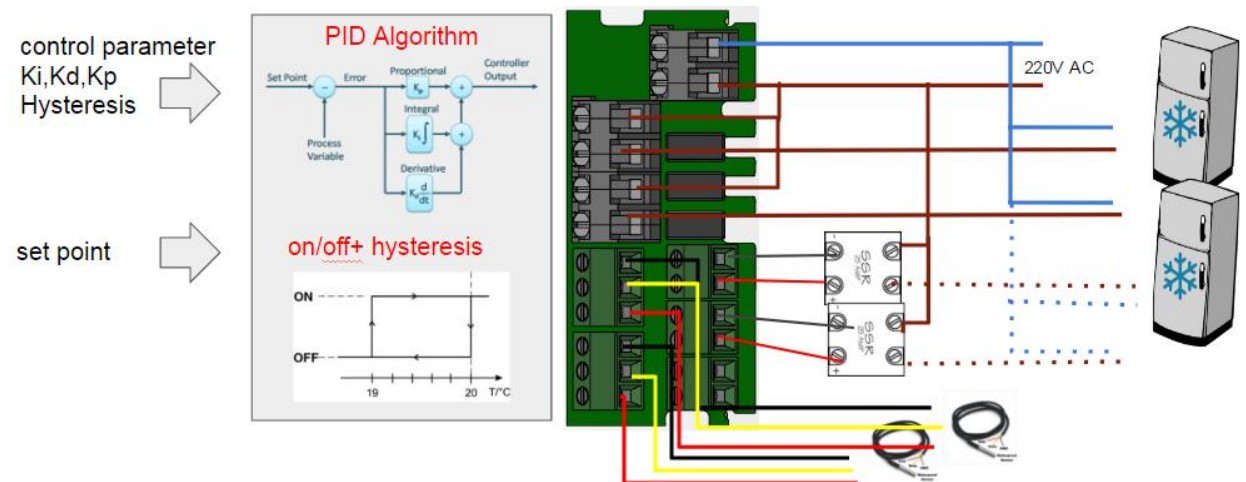

### 3 Smart thermostat application SW

In this chapter the application SW installed and running on the controller is described in order to provide to end user the full understanding about how the smart thermostat can be used and configured

#### 3.1 Basic control principle

The core of this application is to implement a temperature control logic either to drive the heating element (electric or gas fired) in an heating process OR to drive a cooling system (typically a fridge) in a cooling process.

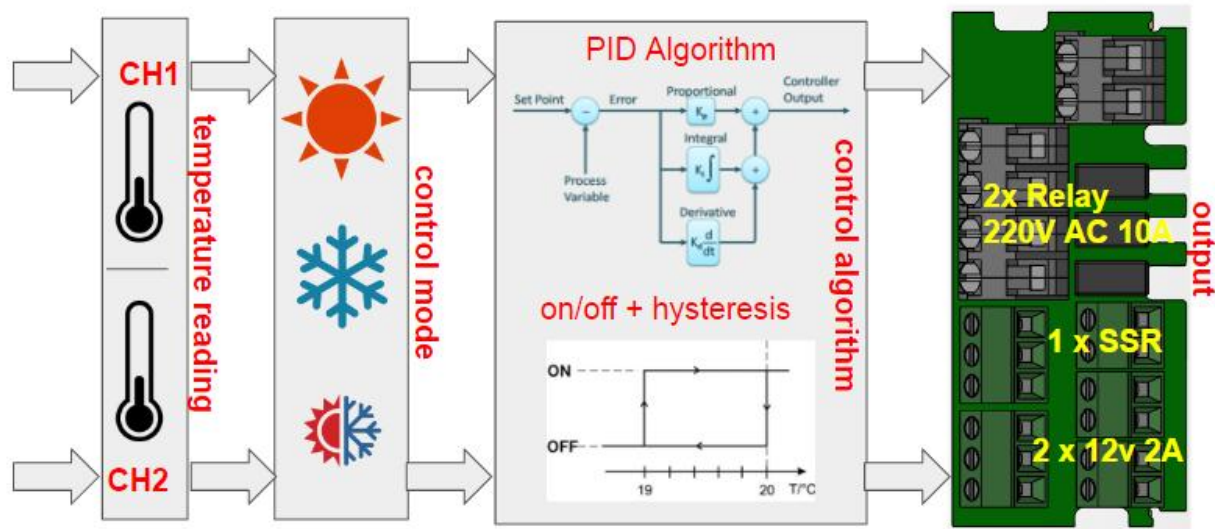

The main variable is the setpoint temperature selected by push buttons and this temperature is the input for the controlling algorithm that can be

#### 1. PID algorithm + PWM control [electric heating element]

Set point is compared with current temperature and the Proportional Integrative Derivative calculation are performed.

$K_i, K_p, K_d$  must be configured or an auto tuning process is be started during set up phase (optional)

PID output drive a PWM power control block in charge to vary the duty cycle of PWM signals from 0 to 100%. The PWM output will drive the load via SSR. In this way a fine control of electric heating element can be performed.

Two other relevant parameter can be configure and impact PID behavior

- n) Window Size --> Period of the PWM signal
- o) Sample Time --> PID sample time

## 2. ON/OFF algorithm [gas heating and fridge cooling]

In this case set point is compared with current temperature and depending if the value is over or under the target the output is put in ON or OFF state driving either the mechanical relay or SSR.

In order to avoid oscillations near the set point an hysteresis / dead zone should be implemented. The range of hysteresis should be configurable.

The ON/OFF control will typically be applied directly to heating systems gas fired or to fridge compressor

### Fridge delay start

In order to avoid fridge compressor motor damage with frequent ON/OFF cycle a it's possible to insert a **fridge delay start**.

In the process parameter menu you can configure delay start parameter independent for CH1 and CH2 with a range value 0 - 240s (default value 0). When the delay is 0 the logic is not applied

When a transition ON → OFF occurs a timer is started that inhibit the ON transition of the fridge. In case of ON transition during delay window the output will be ON when the timers expires. In case of multiple transition during the delay window only the last transition is relevant, if is ON the output will be ON when timers expires if is OFF the output will be ON at the next natural ON.

Below some example on how the logic works

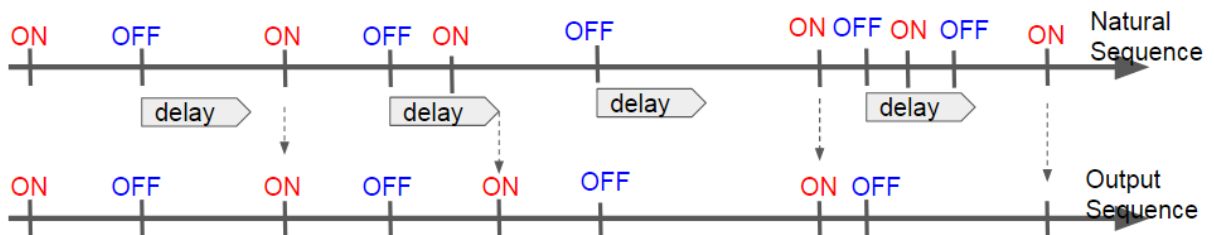

During the delay window the cooling mode icon on the OLED will blink indicating the suspension of action

### 3.2 Smart Thermostat application principle

The smart thermostat implement a complete temperature control logic with 3 control mode and provide also capability to define temperature profile over time.

Main functionalities are

#### 1. Status mode

In this status smartPID acts like a monitor and no automatic action is performed over the 5 outputs. It's anyway possible to activate one of the outputs via menu with "soft switch" function For the SSR out it's possible to regulate the "PWM" percentage from 0 to 100% and so the power applied to a resistive heating element

A timer is also started in this mode

#### 2. RUN mode standard

this is the core mode of the thermostat and according to configuration (heating, cooling, thermostatic) the control process is started an temperature is sampled and compared to the set point in order to take proper action (PID or ON/OFF) on the configured output (relay, SSR, DC)

Once temperature reach the set point a timer and count down are started

In case of configuration of dual heating(cooling) mode both channels are controlled independently

#### 3. RUN mode advanced

In this it should be possible to manage temperature profile by setting proper steps of time and temperature and control ramp slope and soak period. The profile can be associated to each of the two channels independently and can be used in any control mode (heating,cooling,thermostatic)

It's possible to configure the ramp/soak profile adding/editing/viewing the temperature and time parameters in a dedicate menu. Profiles are stored in the internal memory and are addressed by an index In run mode the proper profile index number is selected by the user for each channel. All normal editing operations on profile are available

For each step the profile is defined by a couple for Temperature and Time value and between each step a ramp time is defined and SP is increased linearly between the two set point with single increment of  $1c / 40f$ . If ramp time =0 the SP1 is increased instantly.

There are than two possible algorithm execution

**Ramp/soak = STATIC**

Soak time start when ramp time finish independently from temperature. Each soak period is predefined and is independently from the current temperature and set point.

After each soak period a new set point is defined and a RAMP time defines the time needed to reach the new set point. SP is moved linearly from SP<sub>x</sub> to SP<sub>x+1</sub> with increment of  $1c/40f$

If the next step has soak time=0 (or is the eight steps) the SP is moved to that value and is kept constant until the process abort by user

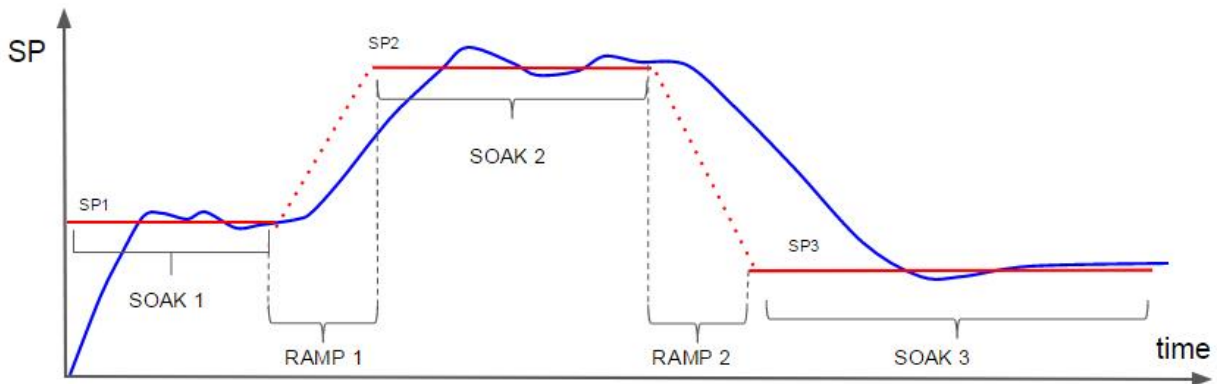

**Ramp/soak = DYNAMIC**

Soak time start when temperature reach the set point. When the temperature reached the SP<sub>x</sub> the soak period is started. After each soak period a new set point is defined and a RAMP time defines the time needed to reach the new set point. SP is moved linearly from SP<sub>x</sub> to SP<sub>x+1</sub> with increment of  $1c/40f$ . If the next step has soak time=0 (or is the eight steps) the SP is moved to that value and is kept constant until the process abort by user.

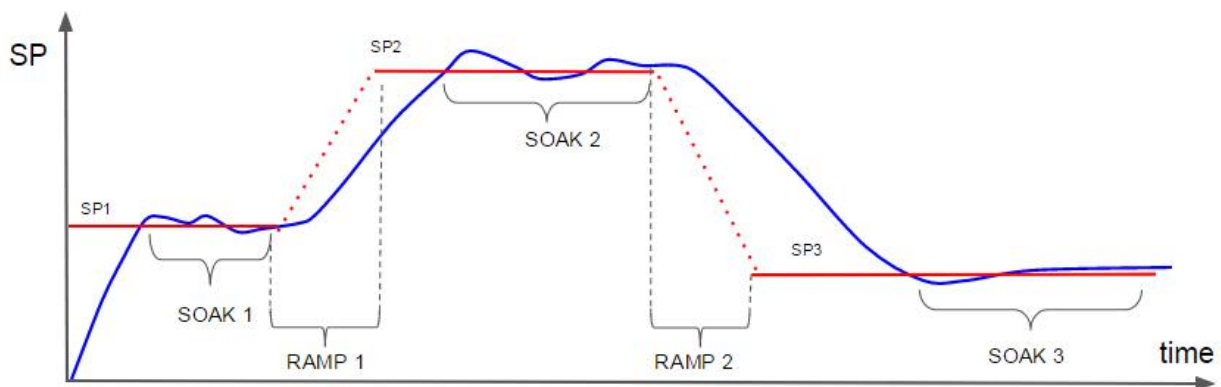

## 4 Menu navigation

In following chapter the complete menu structure and navigation is reported, navigation through menu and selection is performed via tactile switch on the front panel

Each button get its own functions and meaning in the proper context

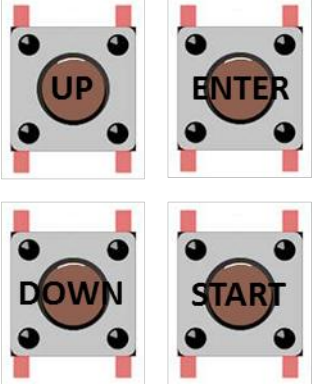
	<ul style="list-style-type: none"> <li>a) UP/DOWN             <ul style="list-style-type: none"> <li>a. Scroll in configuration menu</li> <li>b. Increase decrease temperature value</li> <li>c. Scroll in value in configuration menu</li> </ul> </li> <li>a) ENTER             <ul style="list-style-type: none"> <li>d. Select/enter a specific menu</li> <li>e. Select/confirm a specific value</li> <li>f. Confirm action upon prompt request</li> </ul> </li> <li>b) Start/Stop             <ul style="list-style-type: none"> <li>g. Start process</li> <li>h. Stop Process</li> </ul> </li> </ul>
---	---

### 4.1 Main Menu

After the boot smartPID enter in a standby mode with all outputs off and the user can select the main menu items



The top level menu corresponds to the main SmartPID functions

1. Status Mode --> it's a simple status where the temperature of the two channels is reported and user can activate / deactivate manually all the outputs (soft switch function)
2. Configuration Menu--> under this menu all the specific smartPID and process parameter configuration is performed
3. Connectivity and Log--> in this menu the user can configure all the wifi parameters, see the connection status, configure the remote server for the data logging. This functions are performed in cooperation with the smartphone app [See installation and configuration manual for details]

4. Ramp/Soak --> this menu allow the user to enter/edit/view the temperature profile with ramp/soak temperature and time definition
5. Run Mode--> trough this menu user start the process either standard or advanced
6. Info → reports the HW and SW version

#### 4.2 Status Mode

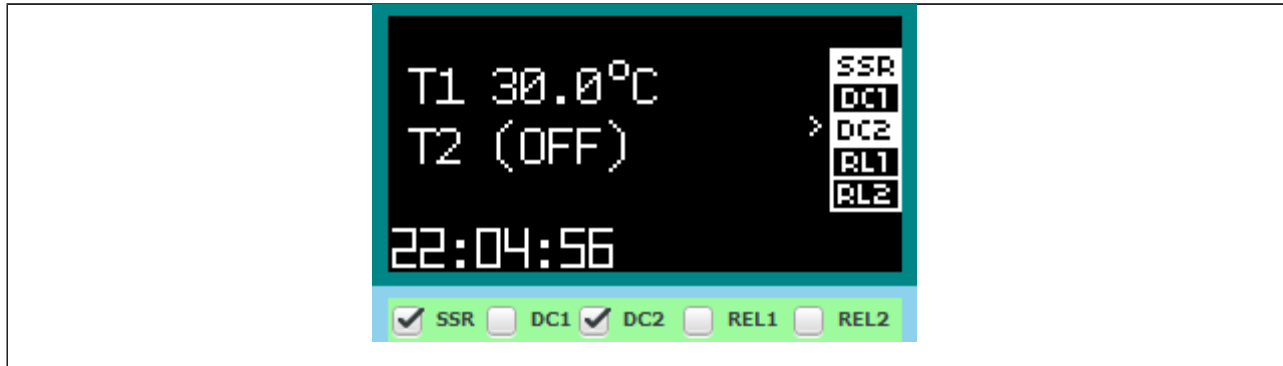

In the status mode the temperature of the T1 and T2 ports is reported as well as the time from the boot of the application. If no temperature probe is connected an error is reported

Moving with UP/DOWN button user can select any output and pressing SET the output can be activated and deactivated. On the OLED the relative label changes the color

Activating the SSR output it's possible to regulate with UP/DOWN button the "PWM" from 0 to 100% this allow to control the power of a heating element.

To exit the status mode long press S/S button

#### 4.3 Configuration

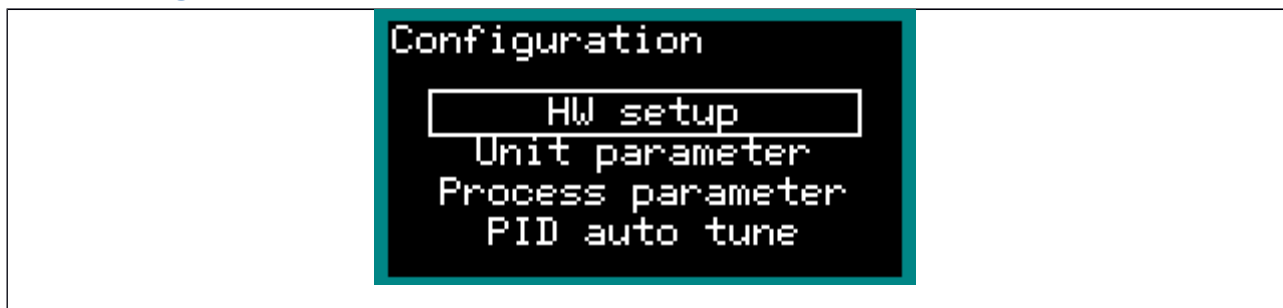



This menu is dedicated to all the configuration operations that typically are done once during the initialization / setup



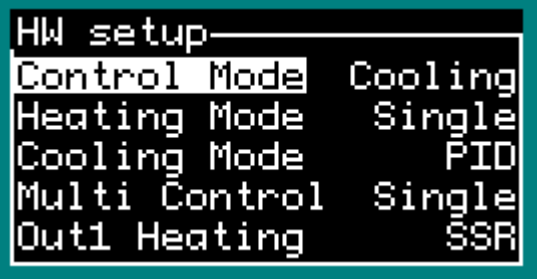

1. HW setup --> the HW resources are configured and assigned to I/O process
2. Unit Parameter--> the main parameter that control the PID process behavior are configured in this menu
3. Process parameter--> smart thermostat process specific parameter are configured in this menu
4. PID auto tune--> this is a special section to configure and run the auto tune process to help end user to calculate critical parameters Kp,Ki,Kd that regulate PID behavior

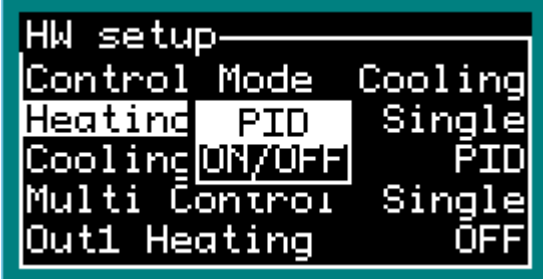
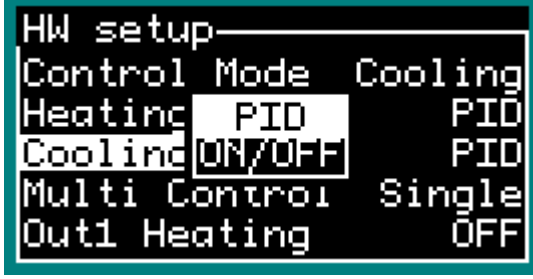
### 4.3.1 HW setup

This section allow to configure physical resources and assign properly to process/channel

	
<p><b>Control Mode</b></p> <p>User can select the control mode between</p> <ul style="list-style-type: none"> <li>-Heating</li> <li>-Cooling</li> <li>-Thermostatic</li> </ul>	
<p><b>Heating mode</b></p> <p>User can select the control algorithm for the heating channel</p> <ul style="list-style-type: none"> <li>-PID</li> <li>-ON/OFF</li> </ul>	
<p><b>Cooling Mode</b></p> <p>User can select the control algorithm for the cooling channel</p> <ul style="list-style-type: none"> <li>-PID</li> <li>-ON/OFF</li> </ul>	

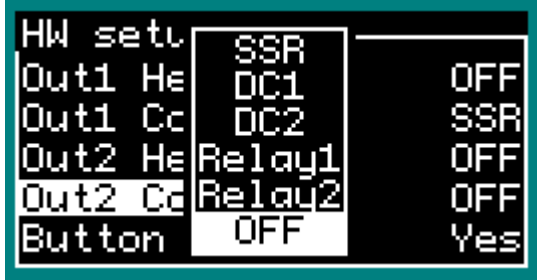



<p><b>Multi control</b></p> <p>Through this menu is possible to select if the thermostat will run a single control process or two process in parallel</p>	 <pre> HW setup Control Mode Cooling Heating Single PID Cooling Dual PID Multi Control Single Out1 Heating OFF                     </pre>
<p><b>OUT 1 (heating and cooling)</b></p> <p>through this menu is possible to assign physical output to the control channel 1 (either heating or cooling )</p> <p>Note that in order to avoid conflict the resources already assigned can't be selected</p>	 <pre> HW setu SSR Cooling DC1 PID Multi C DC2 Dual Out1 He Relay1 OFF Out1 Cc Relay2 SSR Out2 He OFF OFF                     </pre>
<p><b>OUT 2 (heating and cooling)</b></p> <p>through this menu is possible to assign physical output to the control channel 2 (either heating or cooling ) if multi control = dual is selected</p> <p>Note that in order to avoid conflict the resources already assigned can't be selected</p>	 <pre> HW setu SSR Out1 He DC1 OFF Out1 Cc DC2 SSR Out2 He Relay1 OFF Out2 Cc Relay2 OFF Button OFF Yes                     </pre>
<p><b>Button Beep</b></p> <p>this flag enable or disable the sound upon button pressing</p>	 <pre> HW setup Out1 Cooling SSR Out2 Heating OFF Out2 Cooling OFF Button Beep Yes Temp Probe 1 OFF                     </pre>

<p><b>Temp probe 1 &amp; 2</b></p> <p>The proper temperature sensor is selected and assigned to channel 1 and 2</p> <p>Sensor type can be different between channels</p>	 <pre> HW setup----- Out2 Hr----- OFF Out2 C: OFF OFF Button 0518820 Yes Temp P: NTC OFF Temp Probe 2 OFF                     </pre>
--	--

#### 4.3.2 Unit Parameter

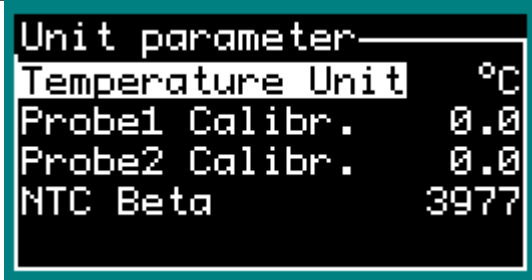
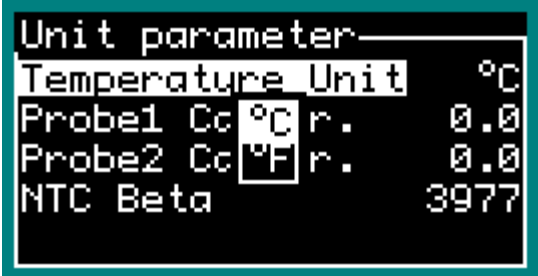
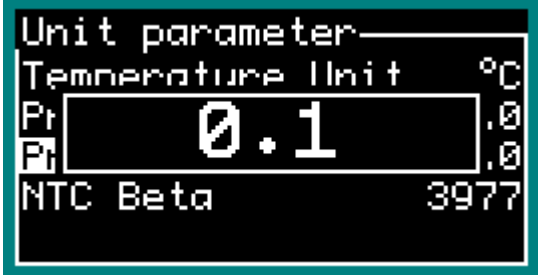
This section allow the user to configure global parameter that regulates the overall SmartpPID behavior

	 <pre> Unit parameter----- Temperature Unit °C Probe1 Calibr. 0.0 Probe2 Calibr. 0.0 NTC Beta 3977                     </pre>
<p><b>Temperature unit</b></p> <p>This menu allow the user to select the proper measurement unit</p> <ul style="list-style-type: none"> <li>-Celsius</li> <li>-Fahrenheit</li> </ul> <p>Same configuration should be reported on the smartphone app</p>	 <pre> Unit parameter----- Temperature Unit °C Probe1 Cc °C r. 0.0 Probe2 Cc °F r. 0.0 NTC Beta 3977                     </pre>
<p><b>Probe Calibration (1 &amp; 2)</b></p> <p>It's possible to add an offset of +/- 5c to the mash temperature probe reading to compensate any measurement error</p>	 <pre> Unit parameter----- Temperature Unit °C Pr 0.1 .0 Pi 0.1 .0 NTC Beta 3977                     </pre>

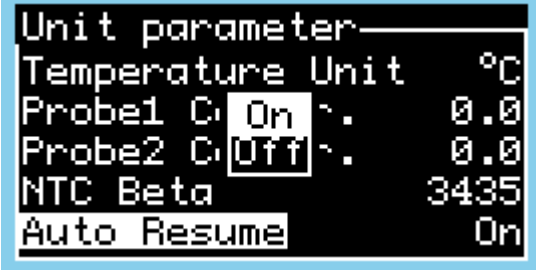
<p><b>NTC beta</b></p> <p>User can select the Beta coefficient for NTC sensor , most common value are reported</p> <p>Beta will affect the temperature reading and so the precision, try to find the proper one according to spec of your NTC</p>	
<p><b>Auto Resume</b></p> <p>When smartPID reboot after a power outage or device watchdog, depending on this parameter the on going session is completely restored)</p> <p>ON automatic restoration</p> <p>OFF user is prompted for restore the session or start a new onw</p>	

#### 4.3.3 Process parameter

This section allow the user to configure all the parameter that are specific for the smart thermostat process, each of them influence the overall process execution

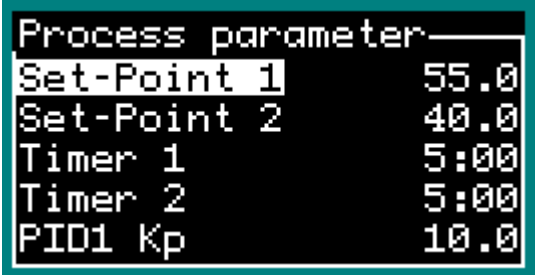
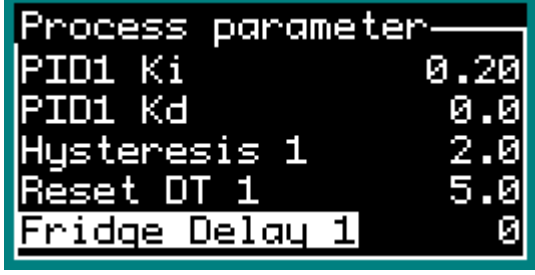
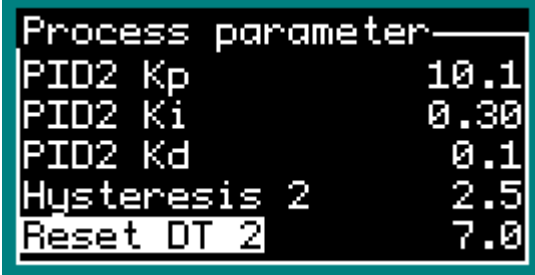
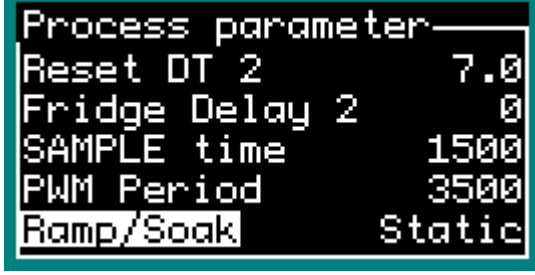
Below table reports for each parameter a short description and the range of valid value

Parameter Type	Parameter	Description	Range	default
Default parameter	Set-Point 1	Default set point for channel 1	-55 +120 c	55c
	Set-Point 2	Default set point for channel 2	-55 +120 c	40c
	Timer 1	Define default count down timer for channel 1		5min
	Timer 2	Define default count down timer for channel 2		5min
Process Parameter	Kp/Ki/Kd For CH1 and CH2	Define the proper constant value for the PID algorithm	Kp x—y Ki x—y Kd x—y	
	SAMPLE time	Define the sample time of temperature in ms	1000ms 4000ms	1500ms
	PWM perido	Define the PWM period/window size for PWM control in ms	500ms 7000ms	3500ms
	Hysteresis For CH1 and CH2	Define the hysteresis in ON/OFF control in C/F	0c 5c	2c
	Reset DT 1 & 2	Define temperature variation from set point to reset the count down timer	2 - 20c	7c
	Fridge delay 1 & 2	Define the duration of the fridge delay start  0 means no delay logic	0 - 240s	0
	Ramp/soak	Define if the control logic is dynamic or static (see proper manual section)	Dynamic Static	Static
Alarms	Sounds Alarms	Define for each alarms if	Set Point	Y

		the buzzer is activated or not	reached Y/N Count Down Expired Y/N Timer reset Y/N Ramp/soak Y/N	
--	--	--------------------------------	---	--

#### 4.3.4 PID auto tuning

This is a special advanced menu that allow to start a specific SW algorithm that try to estimate the best value of KpKiKd constant considering the specific setup

In this section is not reported the complete theory behind this algorithm but just how to configure and start . There are few resources on the internet that explain the Ziegler-Nichols method implemented, as resource starting point refers to Wikipedia page

[https://en.wikipedia.org/wiki/PID\\_controller](https://en.wikipedia.org/wiki/PID_controller)

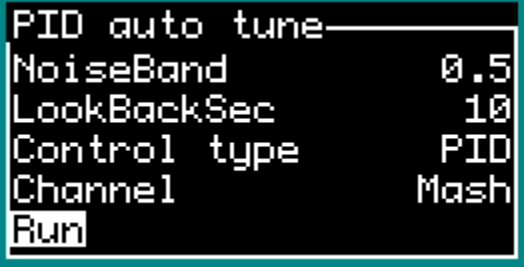
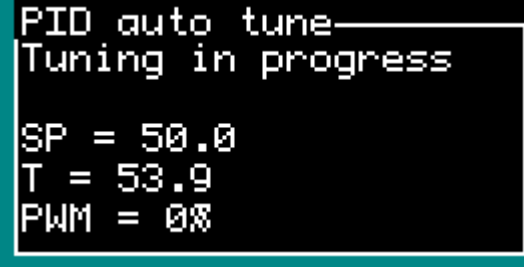
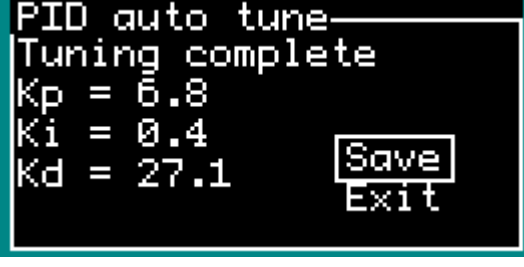
	
<p><b>PID auto tune RUN</b></p> <p>Whene the autotune is in run mode the PID try first to reach the set point using the default parameters</p>	
<p><b>PID auto tune progress</b></p> <p>Once the set point is reached the auto tune starts some step cycle with OutputStep increase and decrease calculating the time to reach SP+- NoiseBand temperature value and evalaute system reaction</p>	
<p><b>PID auto tune complete</b></p> <p>If the algoritmn converge (it can take also one hour) the Kp,Ki,Kd calculated are reported and user can save as default value</p> <p>Notice that the auto tuning process is per channel</p>	

#### 4.4 Ramp/Soak

The ramp/soak feature is based on a concept of “**profile**” that defines the input parameter to the controller

Through this section is possible to:



**VIEW**→ load profile from local EEPROM selecting index number and allow to display the full set of parameter in each sub-menu

**EDIT /DELETE**→ load profile from local EEPROM selecting index number and allow to change/modify/delete all parameter in each sub menu. At the end of the modification user can save on the same index (replace) or with a new index (clone).

**NEW** → allow user to define a new profile from scratch and add all parameters divided in two submenu. For parameter list see the doc spec chapter 3.3.3

At the end of the profile definition the entire profile can be saved in the EEPROM with a proper index

When a new profile should be inserted a profile definition menu is presented



**Profile definition**

For each point of the profile user should define:

SP X that is the starting set point temperature

Ramp Time Y that is the time to move set point from X to X+1

Soak time Z that is the time the temperature is kept constant

If the ramp time = 0 the set point is moved instantly (step)

If the next step has soak time=0 (or is the eight steps) the SP is moved to that value and is kept constant until the process abort by user

```

Profile Definition
SP1 Temp      40.0
Soak1 Time    0:00
Ramp1 Time    0:00
SP2 Temp      40.0
Soak2 Time    0:00
    
```

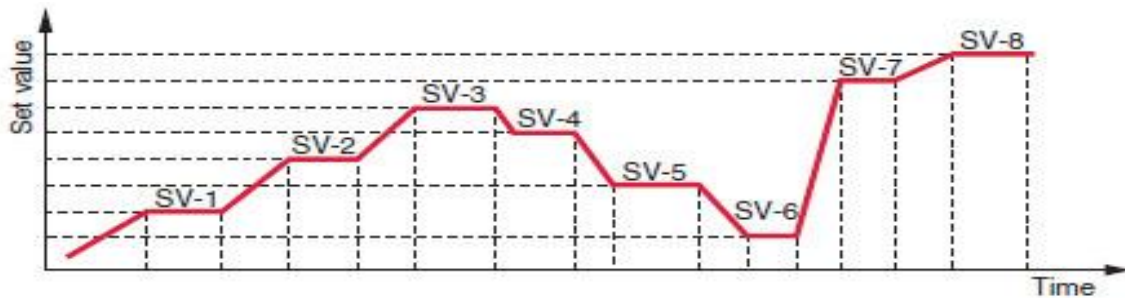



#### 4.5 Connectivity/MQTT

SmartPID can be monitored and controlled from remote via a dedicated smartphone app.

The remote control architecture is based on a client-server paradigm and MQTT protocol. Smartpid connects to the broker and notify data to a remote agent that subscribe the data stream

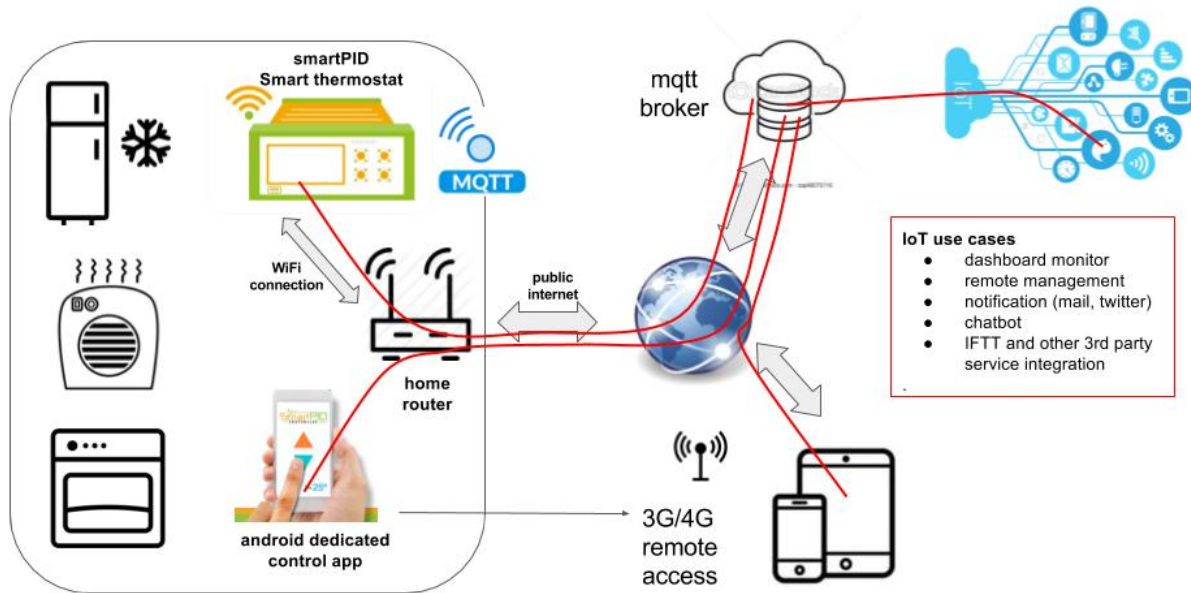

SmartPID controller has on board a WiFi module to connect to home WiFi router. Once connected to the public internet smartPID communicates to a server using standard MQTT protocol and different applications can interact with the controller via server

this type of architecture allow multiple functions and remote management

#### 3. Process Data Logging and monitor

Main process parameter during status mode or run mode (standard and advanced) are pushed with a configurable frequency to the server and the remote smartphone APP subscribe that data do display on a graphic dashboard

- a. Set Point temperature
- b. Current Temperature
- c. PWM percentage
- d. Timers

#### 4. Events remote notifications

Main process events and alarms are asynchronously notified to the remote application

- a. process start/stop
- b. set point reached

- c. proces events
- d. timer expiration

#### 5. Remote commands

Via remote APP it's possible to interact with the controller and modify relevant parameters

- a. set point
- b. count down timer
- c. start/stop processes
- d. pause/resume
- e. Restore after a power down

#### 6. Profiles

User can define ramp/soak profile to be downloaded on the smartPID controller

In order to connect SmartPID controller to home WiFi network and to remote server and to the smartphone app 3 basic operation are need

- 4. SmartPID account creation (sign-up via app)
- 5. WiFi configuration and provisioning
- 6. SmartPID pairing with the app using serial number

Following data are need to complete the 3 steps

WiFi home network

- b) SSID (WiFi network name)
- c) Password

SmartPID account (created during sign-in process)

- b) Login
- c) Password

SmartPID serial number

- c) 14 char unique string [visible on boot screen and INFO menu]

**For a detailed step by step procedure please refer to the specific guide**



#### 4.6 Run mode

Entering the run mode allow the user to start the control process

Two possible run mode are possible

**Standard Mode**--> simple temperature controller according to control mode configured

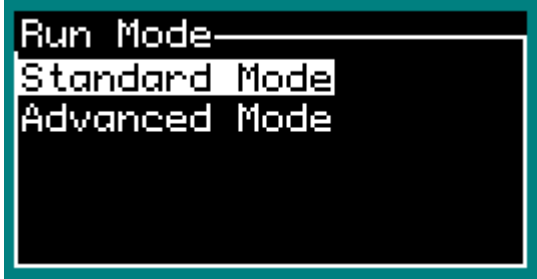
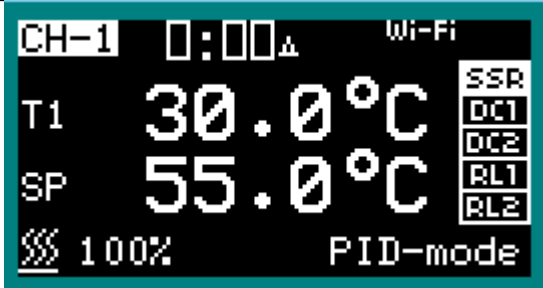
**Advanced Mode** -->set point temperature is controlled according profile (ramp/soak) definition

	
<p><b>Standard Mode</b></p> <p>The system enter the run mode and starts controlling the the CH1 and CH2</p> <p>See “process execution” chapter for details of the information reported on the display</p>	
<p><b>Advanced Mode</b></p> <p>Before entering the advanced mode user is requested to load a profile from the memory or define a new one.</p> <p>Profile can be different for channel 1 and 2</p>	

## 5 Process Execution

Once the controller has started the run mode either standard or advanced the temperature is sampled and the control logi is applied according to parameter configuration (PID or ON/OFF).

The main screen in run mode report following information

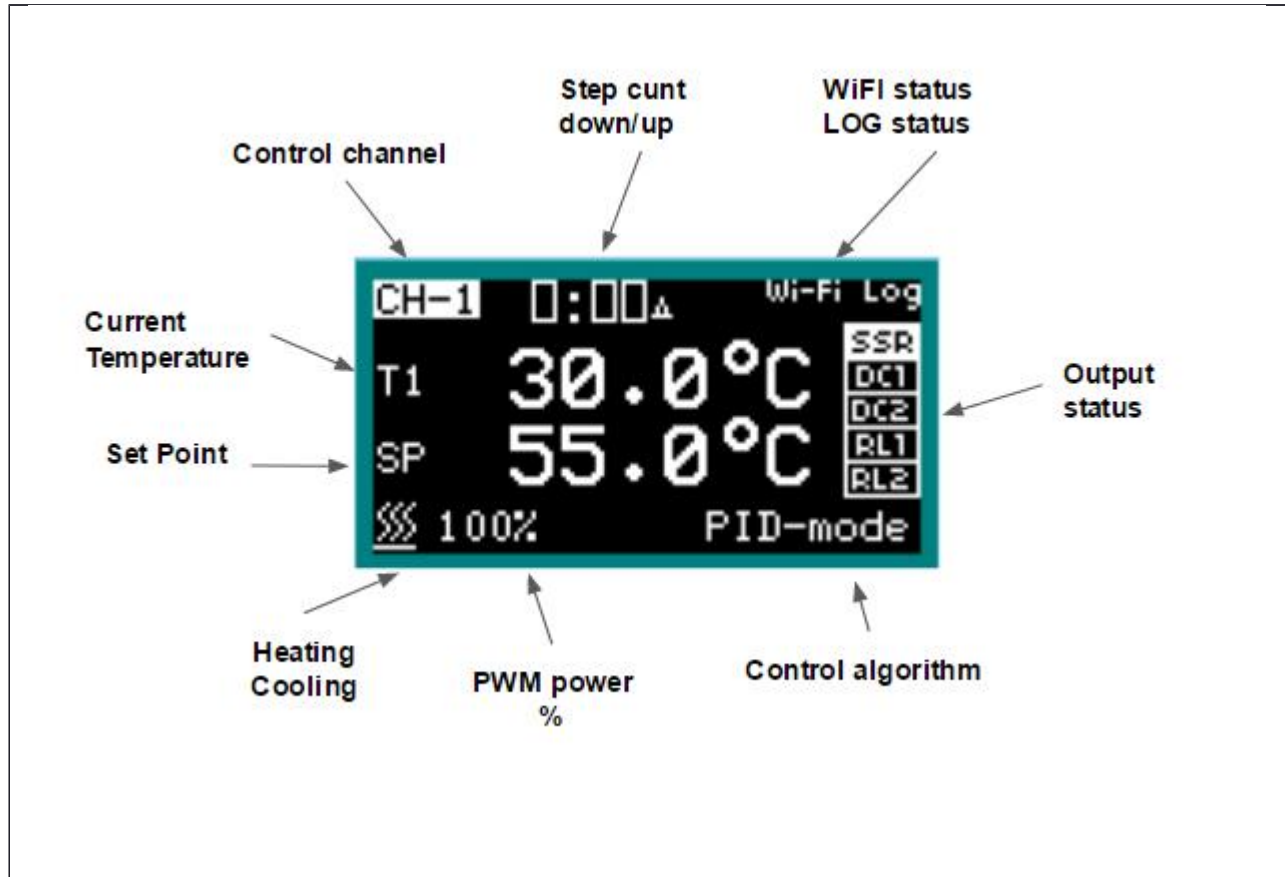

via the push button is possible to

- Switch to the graphic mode --> press SET
- Switch between count UP and count DOWN --> press S/S
- Modify the set point temperature --> UP/DOWN buttons
- Exit the process --> long press S/S button

The graphic mode reports the real time temperature and the set point, graph is automatically updated and scalded

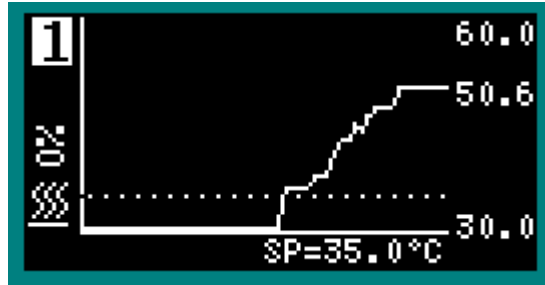

Pressing SET button it's possible to move to the channel 2 screen (if dual mode has been configured)

## 6 Smartphone APP

In this chapter the basic features and use case of the smartphone app are reported in order to control remotely the smartPID controllers

### 6.1 Login and device list

Once completed the setup and provisioning procedure [see specific manual] user can login with it's own account and retrieve the device list configured during setup phase

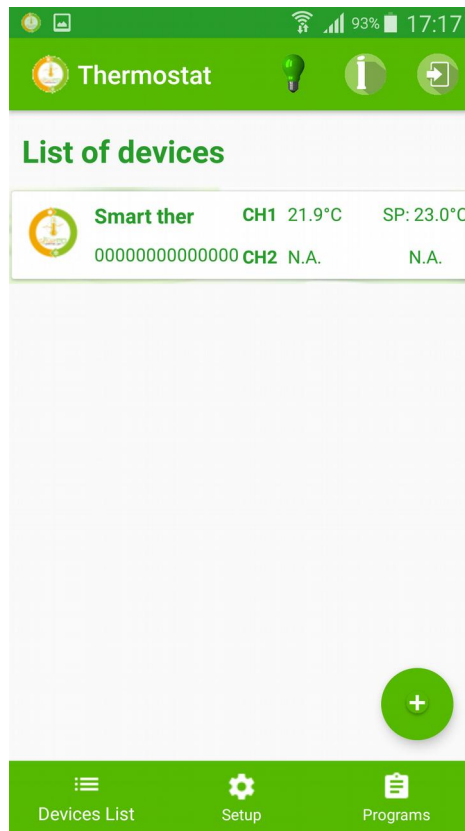

Notice that with one application user can manage multiple smartPID controllers while one controller can be associated to only ONE account.

If the controller is in run mode and is connected to wifi pushing data to the server the set point and temperatures measured on both channels are reported in real time for each device

## 6.2 Main dashboard

Selecting on of the active device in the device list a detailed view of the running process is reported

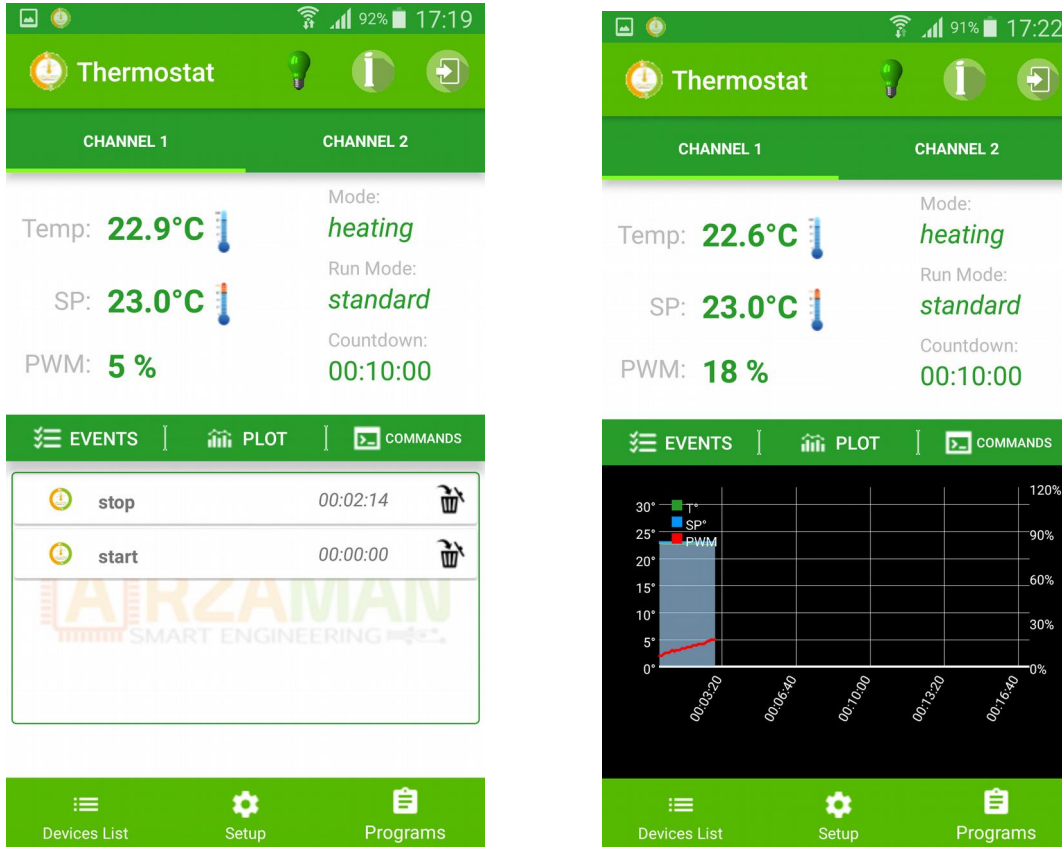

the CH1 and CH2 channels are organized in tab reporting either graphically (PLOT tab) or alphanumeric value of

- set point
- current temperatures
- PWM percentege (0-100%)
- the working mode (heating/cooling/thermostatic)
- ther run mode (standard or advanced)
- count down timer for each phase

In the bottom parts events and asynchronous notifications are reported (set point reached, timer expirations, start/stop events...). Events can be removed from the history taping on the right simbol

### 6.3 Commands

Through the COMMANDS tab user can interact with smartPID sending specific commands to change run time parameters like

- Set point
- Timer duration

After the parameter input user should press SAVE button to send new values to the controller

NOTICE that smartPID must be in RUN MODE to receive the commands otherwise it's discarded

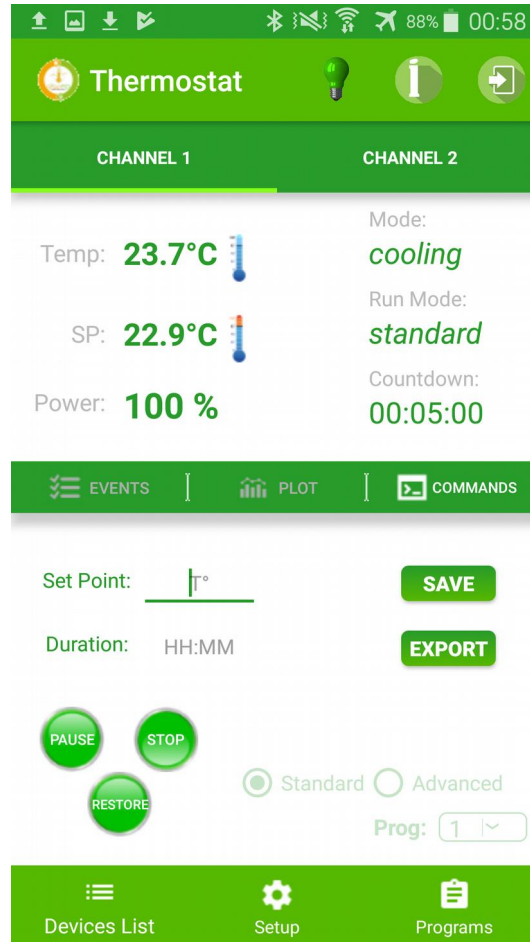

**PAUSE/RESUME** button allow user to suspend the running process (all the outputs are set in Off and the timer frozen) and to resume in a later stage

**START/STOP** button allow user to enter run mode remotely or to abort the process. In case of start command the standard or advanced mode should be specified and in case of advanced a proper program selected for each channel.

**RESTORE** button allows the user to resume a process that has been aborted due to a power down or watchdog action. The procedure has effect if the auto resume flag is configured OFF (see unit parameter)



### 6.4 Data Export

It's possible to export precess data to perform prepossessing and analysis

Log data are stored locally on the smartphone if the application is running and off course smartPID is in run mode sending process data

It' possible to configure the max number of days of retention in the set up tab. The older data are than discarded.

Once user press "EXPORT" button a CSV file is created (process can takes few seconds) and data can be shared with any application (email, google drive, whatsapp..)

For the HomeBrewing app following data are exported with following format

```
DEVICE NAME,DEVICE ID, ABSOLUTE TIME, TIME, MODE, RUN MODE, UNIT, SET POINT, TEMP, PWM
Smart thermostat,00000000000000,28-10-2018 12:47:04,75:54:15,cooling,standard,C,22.9,23.75,100
Smart thermostat,00000000000000,28-10-2018 12:47:08,375:54:20,cooling,standard,C,22.9,23.6875,100
Smart thermostat,00000000000000,28-10-2018 12:47:13,375:54:25,cooling,standard,C,22.9,23.6875,100
```

### 6.5 Setup

In the setup tab user can configure few default parameters

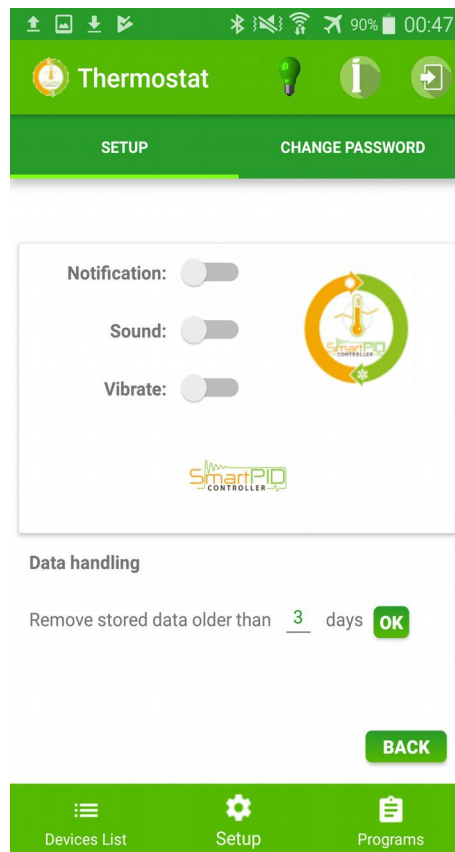

- Number of days for data log storage
- Notification behaviour on the smartphone

## 7 Appendix

### 7.1 Zeigler-Nichols PID tune

Another heuristic tuning method is formally known as the [Ziegler–Nichols method](#), introduced by [John G. Ziegler](#) and [Nathaniel B. Nichols](#) in the 1940s. As in the method above, the  $K_i$  and  $K_d$  gains are first set to zero. The proportional gain is increased until it reaches the ultimate  $K_u$ , at which the output of the loop starts to oscillate.  $T_u$  and the oscillation period are used to set the gains as shown:

**Ziegler–Nichols method**

Control Type	$K_p$	$K_i$	$K_d$
<i>P</i>	$0.50K_u$	-	-
<i>PI</i>	$0.45K_u$	$0.54K_u/T_u$	-
<i>PID</i>	$0.60K_u$	$1.2K_u/T_u$	$3K_uT_u/40$

These gains apply to the ideal, parallel form of the PID controller. When applied to the standard PI form, the integral and derivative time parameters  $T_i$  and  $T_d$  are only dependent on the oscillation period  $T_u$